

PC(D)V液控單向閥

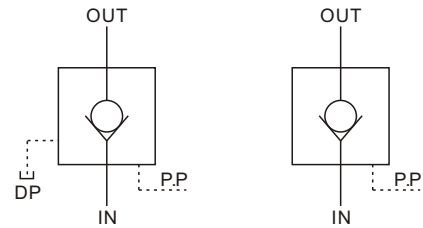

液壓符號:



特 性:

- 液控單向閥通常情況下只允許油液一個方向自由流通，反方向完全不能流過，當液控壓力起作用時，才可以反向流通。

■ 規格說明

型 號	PCV / PCDV-※03	PCV / PCDV-※06	PCV / PCDV-※10
額定流量 (L/min)	60	200	450
最高使用壓力 (bar)	250		
開啓壓力 (bar)	05: 0.5	50: 3.5	

## ■ 型號說明

**PCDV - G 03 - 05 - ET - 10**

①      ②      ③      ④      ⑤      ⑥

① 閥代號:

PCV: 液控單向閥

PCDV: 釋壓型液控單向閥

② 安裝形式:

G: 板式安裝

T: 管式安裝

③ 公稱口徑:

03: 10mm

06: 20mm

10: 32mm

④ 開啓壓力:

05: 0.5bar

50: 3.5bar

⑤ 控制方式:

無: 內控內洩

E: 外控內洩

ET: 外控外洩

⑥ 設計型號

## ■ 壓力降特性

測試條件: 黏度:35cSt 溫度:50℃

### ● PCV/PCDV-T03

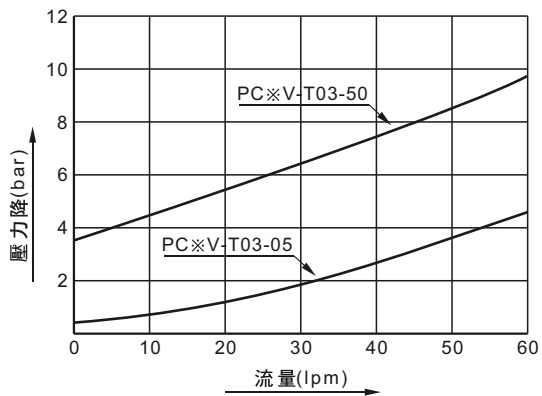

### ● PCV/PCDV-G03

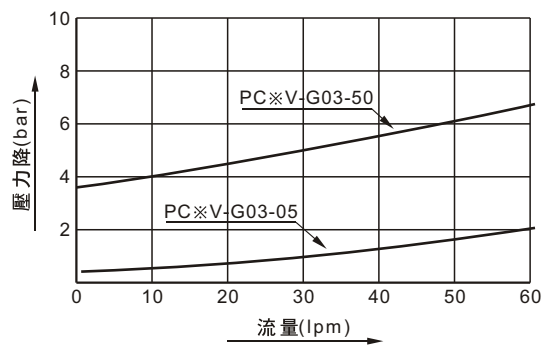

### ● PCDV-T06

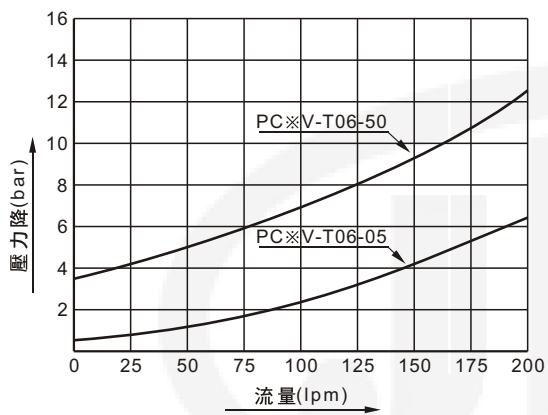

### ● PCDV-G06

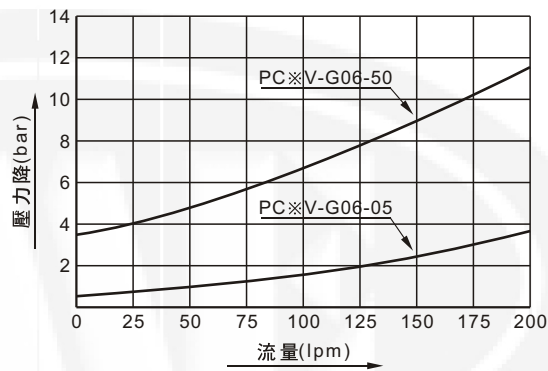

### ● PCDV-T10

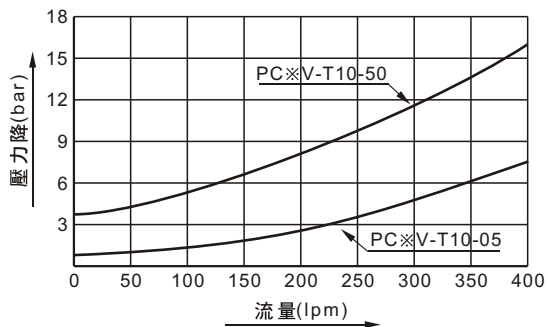

### ● PCDV-G10

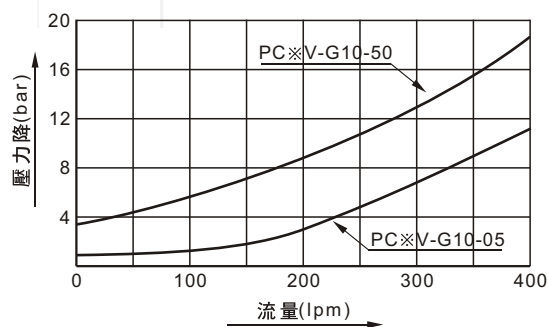

■ 特性曲線

測試條件: 黏度:35cSt 溫度:50°C

● 當卸壓閥打開時, 反向控制液流的壓降

● 最低控制壓力

● PCDV-※03

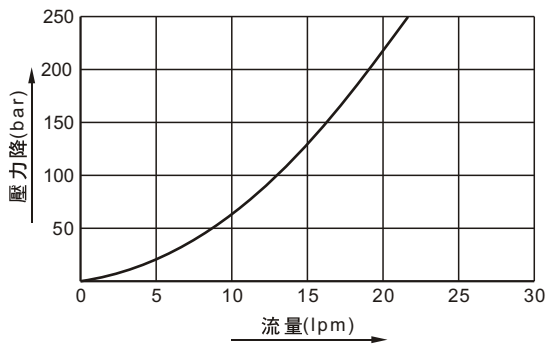

● PCV/PCDV-※03

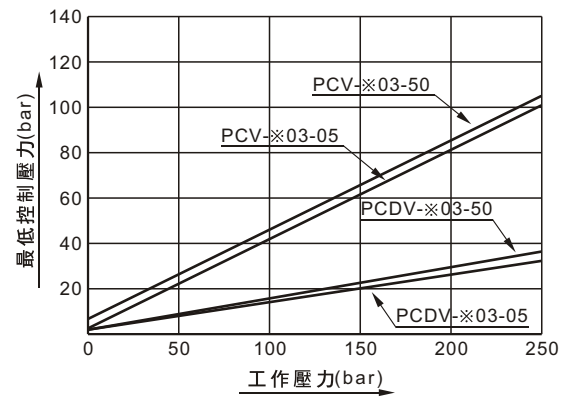

● PCDV-※06

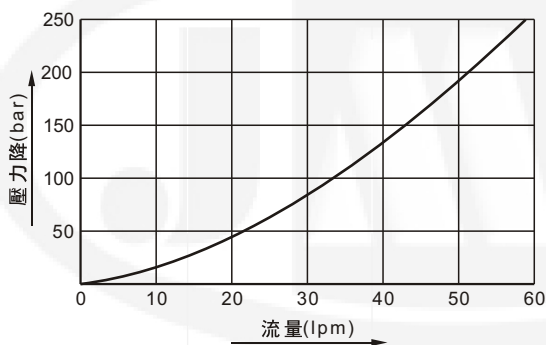

● PCV/PCDV-※06

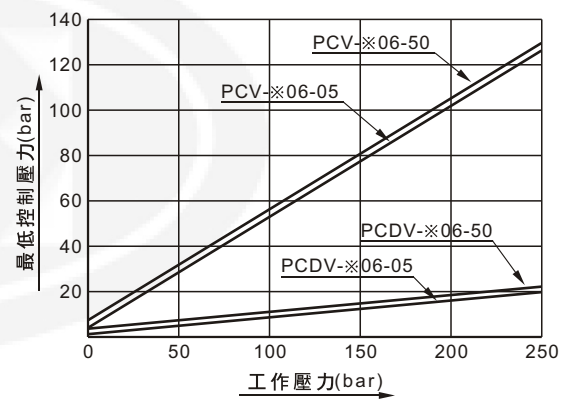

● PCDV-※10

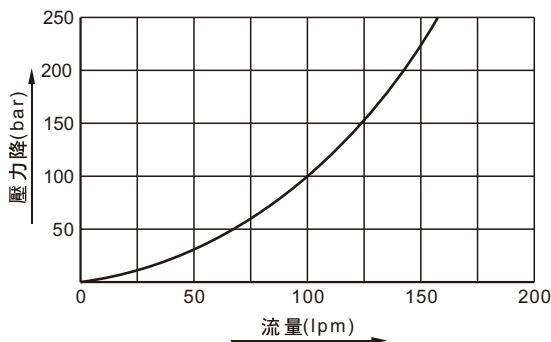

● PCV/PCDV-※10

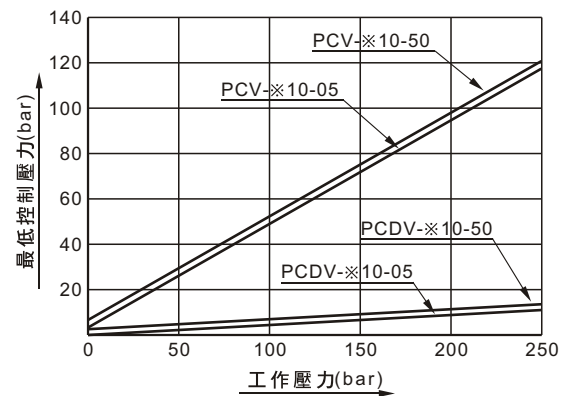

## ■ 尺寸圖

### ● PCV/PCDV-G03/06/10

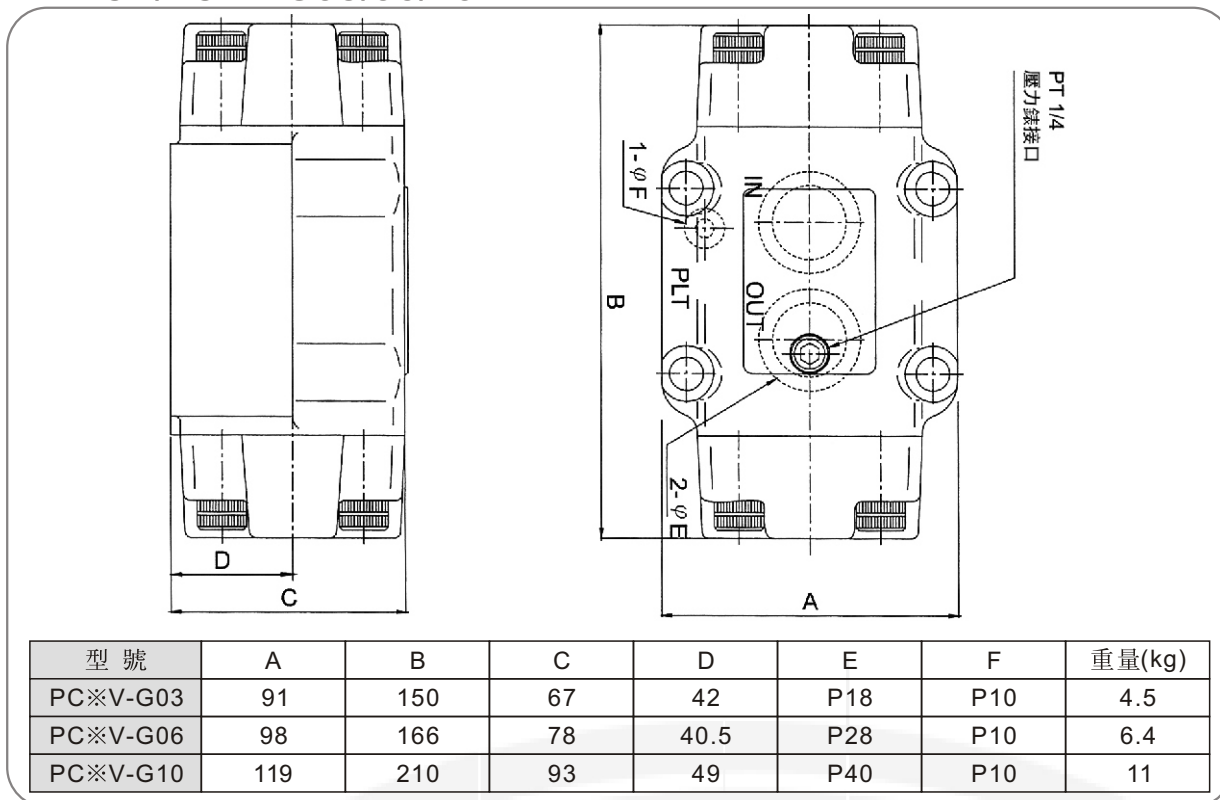

### ● PCV/PCDV-T03/06/10

