

MPR疊加式減壓閥

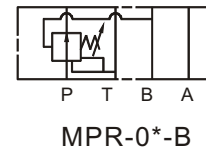
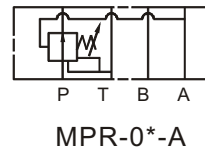
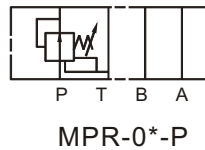
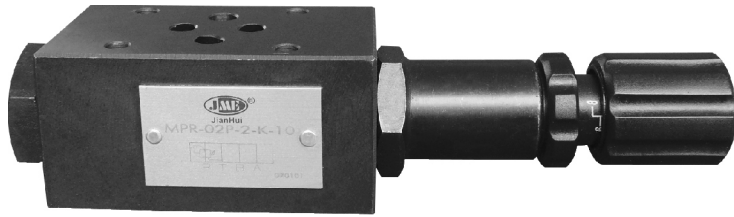

■ 規格說明

型 式	MPR-02-P/A/B		MPR-03-P/A/B	
最高使用壓力	250kgf/cm ² (3550psi)			
壓力調節範圍(kgf/cm ²)	0:1.5-35	1:3-35	2:8-70	3:10-210
最大通過流量	40LPM(10.7GPM)		80LPM(21.3GPM)	
流體過濾精度	25 Micron			
流體溫度範圍	0°C~ 55°C			
工作環境溫度	-25°C ~ 90°C			
流體黏度範圍	10-400 CST			
重 量 (kg)	1.4		3.7	

■ 型號說明

MPR - 02 - P - 1 - K - 10

① ② ③ ④ ⑤ ⑥

① 疊加式減壓閥系列

② 通徑： 02:6mm 03:10mm

③ 控制油路：

P：P孔

A：A孔

B：B孔

④ 壓力調節範圍：

0: 1.5-35kgf/cm²

1: 3-35kgf/cm²

2: 8-70kgf/cm²

3: 10-210kgf/cm²

⑤ 調節型式：

K：旋鈕

無：螺絲調整鈕

⑥ 設計型號



■ 特性曲綫

測試條件：35CST 溫度：50°C

● 壓力降特性

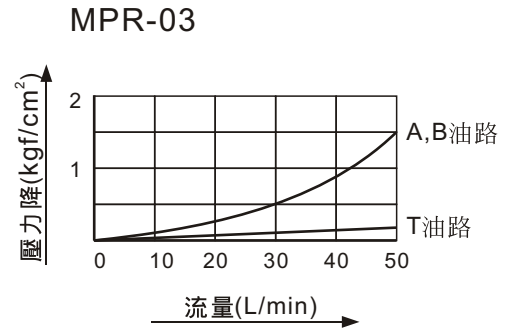
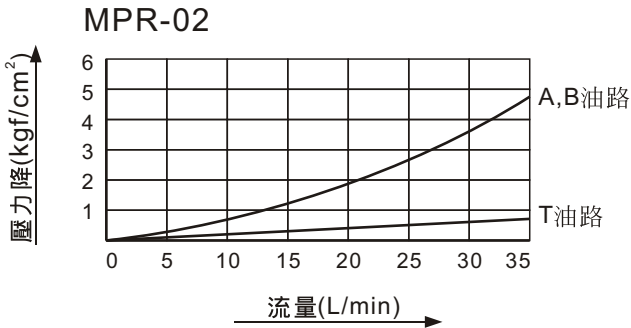

● 滑柱全開時壓力降特性

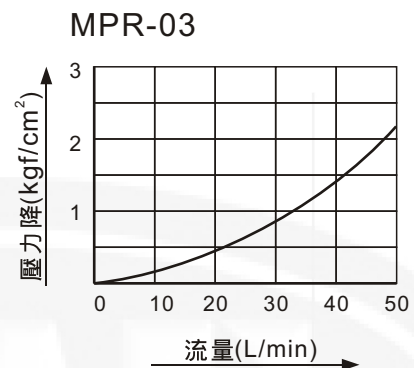
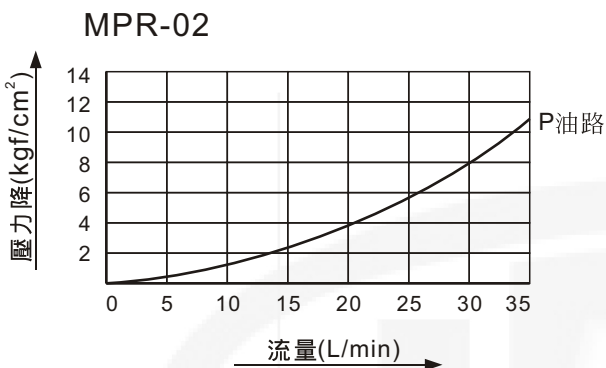

● 最低調整壓力—最大流量特性

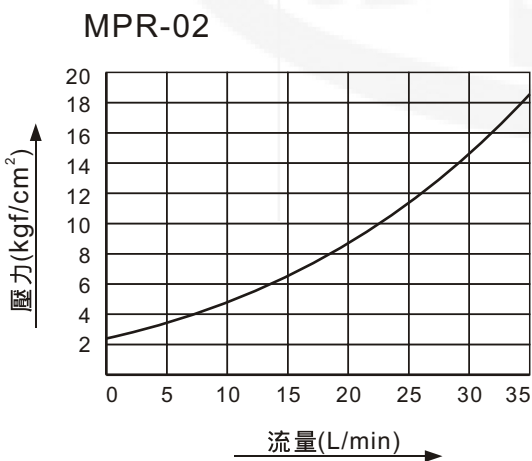

● 先導流量特性

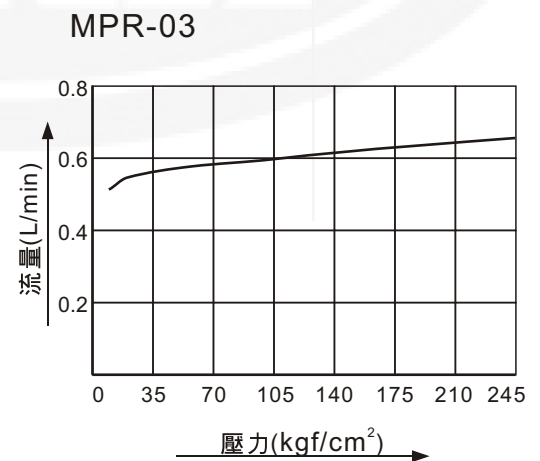

■ 尺寸圖

● MPR-02-P/A/B

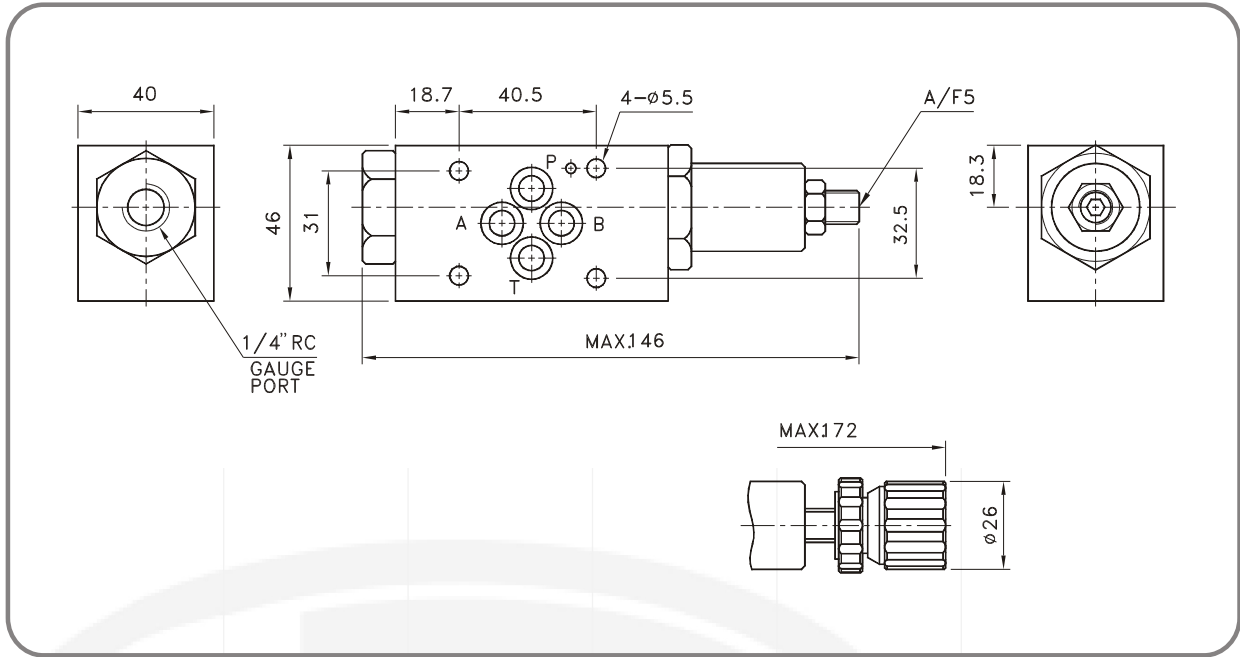

● MPR-03-P/A/B

