

電磁方向閥DWH-G03系列

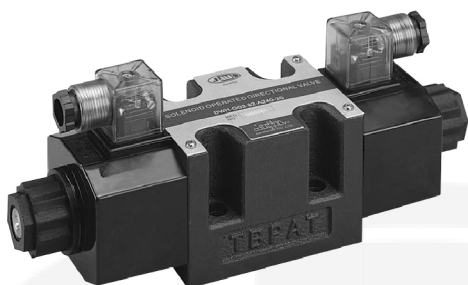
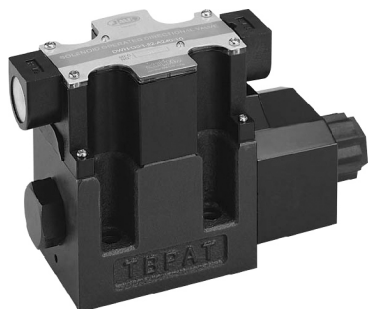

特 性:

- ◆ 浸油式作動電磁管具有耐衝擊、低噪音、壽命長的優點。
- ◆ 濕式電磁閥設計沒有推桿密封圈，沒有因滑動摩擦造成的洩漏，增加閥的壽命。
- ◆ 電磁線圈外表包覆BMC材料，防潮濕絕緣性佳。
- ◆ 全部滑柱和閥體可互換組配，維護簡易。
- ◆ 高壓力大流量等級產品提供低壓力損失及最佳的性能。
- ◆ 直流型電壓可選擇附突波吸收器，確保電控系統的安全性。
- ◆ 一千萬次耐久測試，確保品質的穩定性。
- ◆ 安裝面尺寸適用於ISO、CETOP、NFPA和DIN國際標準規格。

使用性能參數

最高工作壓力	315 kgf/cm ² (4630 PSI)	
最大通過流量	120 LPM (32 GPM)	
最大允許背壓	140 kgf/cm ² (2000PSI)	
最高切換頻率	240 CPM	
流體過濾精度	25 Micron	
防護等級	耐候性符合IP65等級要求	
流體溫度範圍	0°C~ 55°C	
工作環境溫度	-25°C ~ 90°C	
流體黏度範圍	10-400 CST	
固定螺絲扭矩	120 ~ 150 Kgf-cm	
固定螺絲規格	公制	M6×35長×4支
	英制	#1/4-20UNC×1-3/8"長×4支

型號說明
DWH - G 03 - C2 - A220 - 10 - LS

1
2
3
4
5
6
7

① 濕式電磁操作方向閥

② 板式連結

③ 公稱口徑：10通徑

④ 閥柱型式：詳見第19頁閥柱型式表

⑤ 電磁線圈電壓分類：

- A240: AC240V/60HZ, AC220V/50HZ
- A220: AC220V/60HZ, AC200V/50HZ
- A120: AC120V/60HZ, AC110V/50HZ
- A110: AC110V/60HZ, AC100V/50HZ
- D24: DC24V
- D12: DC12V
- R220: AC220V/50, 60HZ ; 交流轉直流
- R110: AC110V/50, 60HZ ; 交流轉直流

⑥ 設計型號：

- 10: 接線盒式
- 20: DIN 43650插座接線式

⑦ 附加編號

- 標準：無
- LS: DC附加突波吸收器

附屬品

型式	安裝螺絲
DWH-G03	M6×35L×4PCS

閥柱型式一覽表

應用	型式	油壓符號	應用	型式	油壓符號
三位置 彈簧中立	C2		兩位置 無彈簧回位	N2	
	C3			N3	
	C4		兩位置 機構定位	D2	
	C40			D3	
	C5		兩位置 彈簧回位 (電磁線圈b)	B2	
	C6			B3	
	C60			B20	
	C7			B40	
	C8		兩位置 彈簧回位 (電磁線圈a)	B2S	
C9		B3S			
C2B		B20S			
C3B		C2BS			
C4B		C3BS			
C40B		C4BS			
C5B		C40BS			
C6B		C5BS			
C60B		C6BS			
C7B		C60BS			
C8B		C7BS			
C9B		C8BS			
C5SB		C9BS			
C8SB		三位置 彈簧中立	C5S		
C9SB			C8S		
			C9S		

電磁線圈性能參數

電磁線圈	種類	電壓 (V)			電流及功率		
		適用電壓 (V)	頻率 (Hz)	允許範圍 ($\pm 10\%$)	啓動電流 (A)	保持電流 (A)	功率 (W)
A.C.	A110	AC100V	50	90-110	4.79	0.86	31
		AC110V	60	99-126	4.2	0.74	32
	A120	AC110V	50	99-121	4.29	0.78	30
		AC120V	60	108-138	3.99	0.70	32
	A220	AC200V	50	180-220	2.31	0.42	30
		AC220V	60	198-253	2.05	0.36	32
	A240	AC220V	50	198-242	2.04	0.37	29
		AC240V	60	216-274	1.88	0.33	32
R110	AC110V	50/60	99-126	0.47	0.47	46	
	R220	AC220V	50/60	198-253	0.24	0.24	46
D.C.	D12	DC12V		10.8-13.2	2.58	2.58	32
	D24	DC24V		21.6-26.4	1.33	1.33	32

技術參考資料:

- 耐電壓測試1500v/sec。
- 絕緣電阻100m Ω 以上。
- 特殊電壓請洽本公司業務部。

壓力降特性測試
測試系統:

1. 受測電磁閥
2. 油泵
3. 壓力感測器
4. 流量感測器
5. 壓力閥
6. 流量調整閥

測試條件:

- 壓力: 70kgf/cm² (1000PSI)
- 流量: 140 LPM (37GPM)
- 黏度: 35 CST

測試迴路

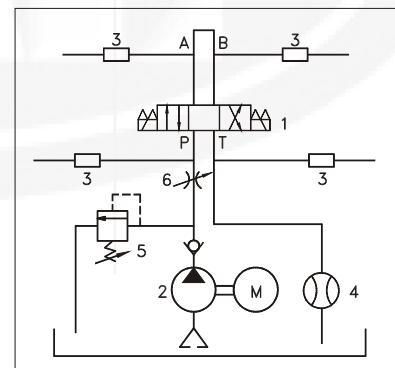

壓力降曲線表

閥柱型式	壓力降曲線編號				
	P→A	B→T	P→B	A→T	P→T
C2	6	6	6	6	—
C3	7	7	7	7	5
C4	6	7	6	7	—
C40	6	7	6	7	—
C5	5	2	2	5	8
C6	2	2	2	2	5
C60	1	1	1	1	4
C7	7	6	7	6	—
C8	6	6	6	7	—
C9	7	6	6	6	—
B2	2	2	6	6	—
B3	3	3	6	6	—
B20	5	—	5	—	—

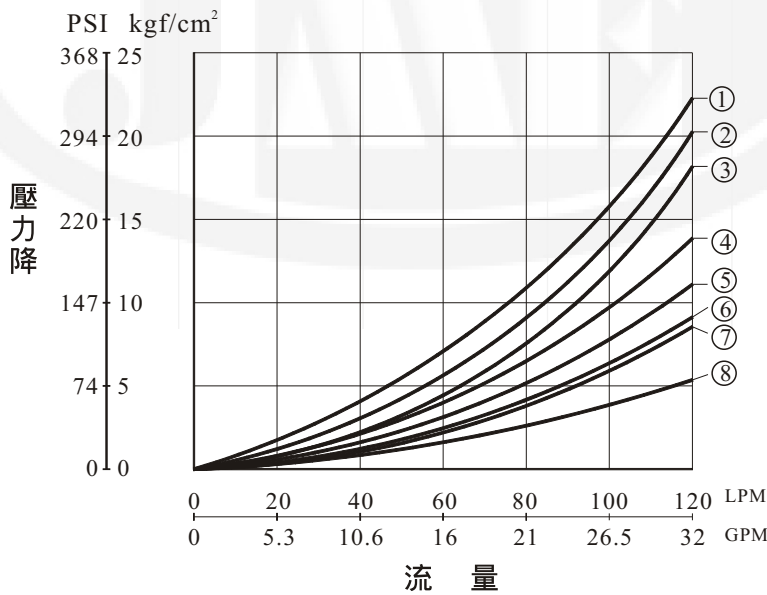
■ 壓力降曲線圖

■ 黏度比對系數

黏度	CST	15	20	30	40	50	60	70	80	90	100
	SSU	77	98	141	186	232	278	324	371	417	464
系數(G)		0.81	0.87	0.96	1.03	1.09	1.14	1.19	1.23	1.27	1.30

■ 壓力損失 ($\Delta P'$) 可從下列公式計算得之 $\Delta P' = \Delta p (G/0.85)$

反應時間測試

■ 測試系統:

1. 受測電磁閥
2. 油泵
3. 壓力感測器
4. 流量感測器
5. 壓力閥
6. 流量調整閥

■ 測試條件:

壓力: 160kgf/cm² (2000PSI)

流量: 120 LPM (32GPM)

黏度: 35 CST

■ 測試結果:

型號	反應時間(SEC)	
	T1	T2
DWH-G03-AC	0.02	0.02
DWH-G03-DC	0.07	0.07
DWH-G03-RF	0.07	0.07

測試迴路

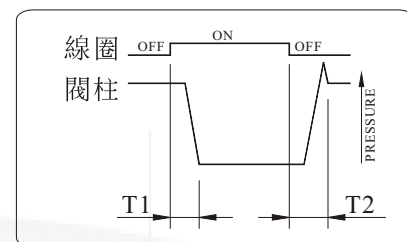
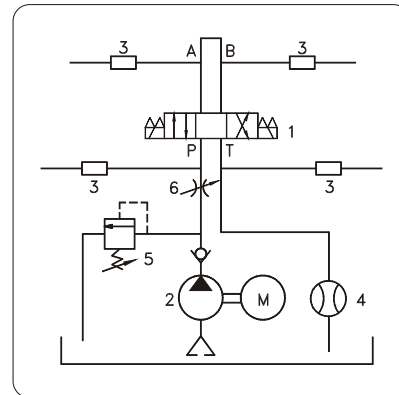

附加突波吸收器選擇

■ 電磁閥型式: DWH-G03-***-D**-**-LS

■ 特性:

- 抑制衝擊電壓。
- 消除繼電器作動時的瞬間火花。
- 延長繼電器使用壽命。

■ 衝擊電壓圖形:

標準DC電磁閥衝擊電壓波形

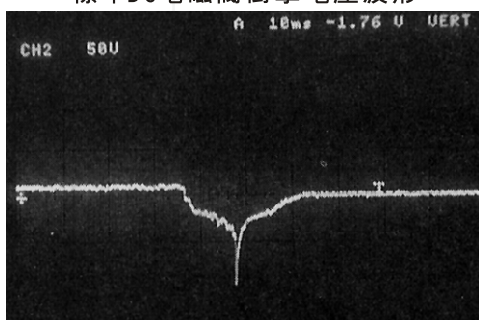

附加突波吸收器衝擊電壓波形

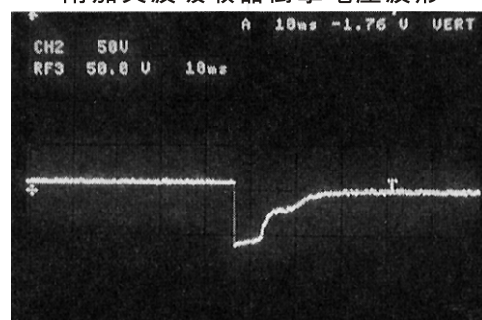

電磁方向閥性能參數表







DWH-G03 AC系列

各種閥柱在各階段壓力 kgf/cm ² (PSI)所能通過的最大流量LPM(GPM)								
閥柱型號 常態位置	P→A,B→T P→B,A→T						P→A	
	50 (735)	100 (1470)	150 (2200)	210 (3000)	250 (3675)	315 (4630)	50 (735)	100 (1470)
C2 	100(26.6)	100(26.6)	100(26.6)	100(26.6)	100(26.6)	100(26.6)	100(26.6)	54(14.4) 38(10.1)
C3 	100(26.6)	100(26.6)	100(26.6)	100(26.6)	100(26.6)	100(26.6)	100(26.6)	100(26.6)
C4 	100(26.6)	100(26.6)	100(26.6)	100(26.6)	100(26.6)	100(26.6)	100(26.6)	54(14.4) 42(11.2)
C40 	100(26.6)	100(26.6)	100(26.6)	100(26.6)	100(26.6)	100(26.6)	100(26.6)	100(26.6) 75(20)
C5 	88(23.5) 82(21.9)	88(23.5) 82(21.9)	88(23.5) 82(21.9)	88(23.5) 82(21.9)	88(23.5) 82(21.9)	—	100(26.6)	100(26.6)
C6 	84(22.4) 75(20)	84(22.4) 75(20)	84(22.4) 75(20)	84(22.4) 75(20)	84(22.4) 75(20)	—	100(26.6) 95(25.3)	100(26.6) 95(25.3)
C7 	100(26.6)	100(26.6)	100(26.6)	100(26.6)	100(26.6)	100(26.6)	63(16.8)	63(16.8)
C8 	100(26.6)	100(26.6)	100(26.6) 75(20)	44(11.7) 75(20)	30(8) 75(20)	19(5.0) 75(20)	100(26.6)	100(26.6) 53(14.0)
C9 	100(26.6)	100(26.6)	100(26.6)	100(26.6)	100(26.6)	100(26.6)	57(15.2)	57(15.2)
B2 	90(24) 72(19.2)	90(24) 72(19.2)	90(24) 72(19.2)	90(24) 72(19.2)	90(24) 72(19.2)	90(24) 72(19.2)	63(16.8)	63(16.8)
B3 	89(23.7) 81(21.6)	89(23.7) 81(21.6)	89(23.7) 81(21.6)	89(23.7) 81(21.6)	89(23.7) 81(21.6)	89(23.7) 81(21.6)	100(26.6)	100(26.6)
B20 	—	—	—	—	—	—	81(21.6)	29(7.7)
D2 	100(26.6)	100(26.6)	100(26.6)	100(26.6)	100(26.6)	100(26.6)	60(16)	40(10.7)
D3 	100(26.6)	100(26.6)	100(26.6)	100(26.6)	100(26.6)	100(26.6)	70(18.7)	60(16)

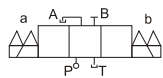
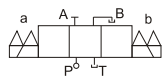
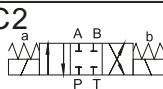
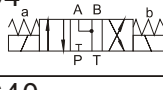
註：表框裏的值是在飽和溫度和標準電壓的90%條件下所能通過的最大流量。



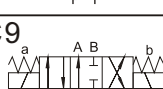
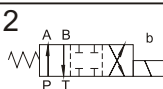
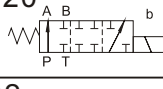
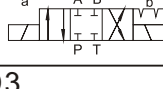





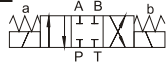

電磁方向閥性能參數表

DWH-G03 AC系列

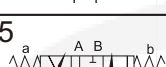
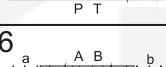
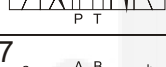
各種閥柱在各階段壓力 kgf/cm ² (PSI)所能通過的最大流量LPM(GPM)										
閥柱型號 常態位置	P→A 				P→B 					
	150 (2200)	210 (3000)	250 (3675)	315 (4630)	50 (735)	100 (1470)	150 (2200)	210 (3000)	250 (3675)	315 (4630)
C2 	40(10.7)	28(7.5)	25(6.7)	20(5.3)	100(26.6)	54(14.4)	40(10.7)	28(7.5)	25(6.7)	20(5.3)
	27(7.2)	17(4.5)	13(3.5)	10(2.7)		38(10.1)	27(7.2)	17(4.5)	13(3.5)	10(2.6)
C3 	100(26.6)	100(26.6)	100(26.6)	100(26.6)	100(26.6)	100(26.6)	100(26.6)	100(26.6)	100(26.6)	100(26.6)
C4 	30(7.8)	23(6.1)	18(4.8)	14(3.7)	100(26.6)	54(14.4)	30(7.8)	23(6.1)	18(4.8)	14(3.7)
	27(7.2)	16(4.3)	11(2.9)	8(2.1)		42(11.2)	27(7.2)	16(4.3)	11(2.9)	8(2.1)
C40 	33(8.8)	28(7.5)	22(5.9)	18(4.8)	100(26.6)	100(26.6)	33(8.8)	28(7.5)	22(5.9)	18(4.8)
	23(6.1)	21(5.6)	15(4.0)	12(3.2)		75(20)	23(6.1)	21(5.6)	15(4.0)	12(3.2)
C5 	100(26.6)	100(26.6)	100(26.6)	-	100(26.6)	100(26.6)	100(26.6)	100(26.6)	100(26.6)	100(26.6)
C6 	100(26.6)	100(26.6)	100(26.6)	-	100(26.6)	100(26.6)	100(26.6)	100(26.6)	100(26.6)	-
	95(25.3)	95(25.3)	95(25.3)		95(25.3)	95(25.3)	95(25.3)	95(25.3)	95(25.3)	
C7 	63(16.8)	63(16.8)	63(16.8)	63(16.8)	63(16.8)	63(16.8)	63(16.8)	63(16.8)	63(16.8)	63(16.8)
C8 	37(9.9)	34(9.0)	28(7.5)	20(5.3)	100(26.6)	61(16.3)	33(8.8)	27(7.2)	20(5.3)	16(4.3)
	32(8.5)	28(7.5)	21(5.6)	15(4.0)		48(12.8)	27(7.2)	21(5.6)	15(4.0)	9(2.4)
C9 	57(15.2)	57(15.2)	57(15.2)	57(15.2)	100(26.6)	53(14.1)	47(12.5)	45(12.0)	40(10.7)	34(9.0)
						40(10.7)	37(9.9)	34(9.0)	29(7.7)	25(6.6)
B2 	63(16.8)	63(16.8)	63(16.8)	63(16.8)	63(16.8)	78(20.8)	45(12.0)	43(11.5)	38(10.1)	32(8.5)
						74(19.7)	38(10.1)	36(9.6)	31(8.3)	27(7.2)
B3 	100(26.6)	100(26.6)	100(26.6)	100(26.6)	100(26.6)	100(26.6)	95(25.3)	82(21.9)	75(20)	65(17.3)
							89(23.7)	84(22.4)	77(20.5)	70(18.7)
B20 	19(5.0)	12(3.2)	9(2.4)	7(1.9)	100(26.6)	80(21.3)	32(8.5)	25(6.7)	20(5.3)	14(3.7)
						42(11.2)	28(7.5)	22(5.9)	17(4.5)	12(3.2)
D2 	40(10.7)	40(10.7)	30(8)	28(7.5)	60(16)	40(10.7)	40(10.7)	40(10.7)	30(8)	28(7.5)
D3 	60(16)	60(16)	42(11.2)	36(9.6)	70(18.7)	60(16)	60(16)	60(16)	42(11.2)	36(9.6)



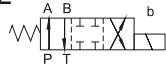
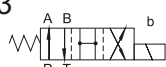







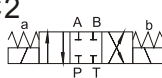
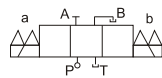

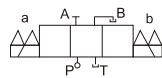

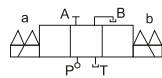

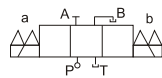

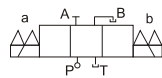
電磁方向閥性能參數表

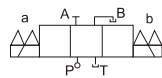
DWH-G03 DC系列

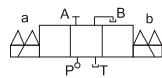
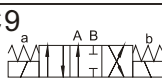
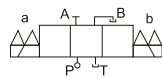
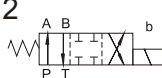
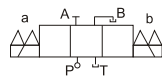
各種閥柱在各階段壓力 kgf/cm ² (PSI)所能通過的最大流量LPM(GPM)								
閥柱型號 常態位置	P→A,B→T P→B,A→T						P→A	
	50 (735)	100 (1470)	150 (2200)	210 (3000)	250 (3675)	315 (4630)	50 (735)	100 (1470)
C2 	120(32)	120(32)	120(32)	120(32)	120(32)	120(32)	120(32)	120(32) 100(26.6)
C3 	120(32)	120(32)	120(32)	120(32)	120(32)	120(32)	120(32)	120(32)
C4 	120(32)	120(32)	120(32)	120(32)	120(32)	120(32)	120(32)	120(32) 100(26.6)
C40 	120(32)	120(32)	120(32)	97(25.9)	78(20.8)	60(16)	120(32)	120(32) 115(30.4)
C5 	100(26.6)	100(26.6)	100(26.6)	100(26.6)	100(26.6)	100(26.6)	100(26.6)	100(26.6)
C6 	100(26.6)	100(26.6)	100(26.6)	100(26.6)	100(26.6)	100(26.6)	100(26.6)	100(26.6)
C7 	120(32)	120(32)	120(32)	120(32)	120(32)	120(32)	65(17.3)	65(17.3)
C8 	120(32)	120(32)	120(32)	97(25.9)	78(20.8)	66(17.6)	120(32)	120(32)
C9 	120(32)	120(32)	120(32)	120(32)	120(32)	120(32)	65(17.3)	65(17.3)
B2 	95(25.3)	95(25.3)	95(25.3)	95(25.3)	95(25.3)	95(25.3)	69(18.4)	69(18.4)
B3 	89(23.7)	89(23.7)	89(23.7)	89(23.7)	89(23.7)	89(23.7)	120(32)	120(32)
B20 	—	—	—	—	—	—	85(22.7)	35(9.3)
D2 	120(32)	120(32)	120(32)	120(32)	120(32)	120(32)	60(16)	40(10.7)
D3 	120(32)	120(32)	120(32)	120(32)	120(32)	120(32)	70(18.6)	60(16)

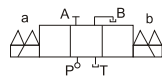
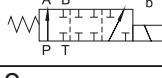
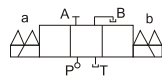
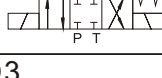
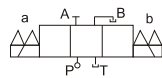
電磁方向閥性能參數表

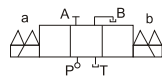
DWH-G03 DC系列

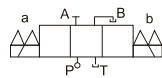
各種閥柱在各階段壓力 kgf/cm ² (PSI)所能通過的最大流量LPM(GPM)											
閥柱型號 常態位置	P→A				P→B						
	150 (2200)	210 (3000)	250 (3675)	315 (4630)	50 (735)	100 (1470)	150 (2200)	210 (3000)	250 (3675)	315 (4630)	
C2											
	73(19.3)	63(16.6)	54(14.3)	37(9.8)	120(32)	120(32)	73(19.3)	63(16.6)	54(14.3)	37(9.8)	
	55(14.5)	48(12.7)	38(10.1)	29(7.7)		100(26.6)	55(14.5)	48(12.7)	38(10.1)	29(7.7)	
C3											
	120(32)	120(32)	120(32)	120(32)	120(32)	120(32)	120(32)	120(32)	120(32)	120(32)	
C4											
	90(24)	73(19.5)	60(16)	47(12.5)	120(32)	120(32)	90(24)	73(19.5)	60(16)	47(12.5)	
	78(20.8)	64(17.1)	51(13.6)	39(10.4)		100(26.6)	78(20.8)	64(17.1)	51(13.6)	39(10.4)	
C40											
	75(20)	54(14.4)	42(11.2)	37(9.9)	120(32)	120(32)	75(20)	54(14.4)	42(11.2)	37(9.9)	
	50(13.3)	39(10.4)	30(8)	21(5.6)		115(30.7)	50(13.3)	39(10.4)	30(8)	21(5.6)	
C5											
	100(26.6)	100(26.6)	100(26.6)	-	100(26.6)	100(26.6)	100(26.6)	100(26.6)	100(26.6)	100(26.6)	
C6											
	100(26.6)	100(26.6)	100(26.6)	-	100(26.6)	100(26.6)	100(26.6)	100(26.6)	100(26.6)	100(26.6)	
C7											
	65(17.3)	65(17.3)	65(17.3)	65(17.3)	65(17.3)	65(17.3)	65(17.3)	65(17.3)	65(17.3)	65(17.3)	
C8											
	68(18.1)	51(13.6)	37(9.9)	27(7.2)	120(32)	85(22.7)	50(13.3)	36(9.6)	25(6.7)	19(5.0)	
	52(13.9)	39(10.4)	28(7.5)	18(4.8)		65(17.3)	40(10.7)	28(7.5)	15(4.0)	12(3.2)	
C9											
	65(17.3)	65(17.3)	65(17.3)	65(17.3)	120(32)	100(26.6)	94(25.1)	85(22.7)	76(20.3)	70(18.7)	
				85(22.7)		80(21.3)	74(19.7)	54(14.4)	49(13.1)		
B2											
	69(18.4)	69(18.4)	69(18.4)	69(18.4)	69(18.4)	120(32)	77(20.5)	63(16.8)	57(15.2)	45(12)	
					66(17.6)		55(14.7)	44(11.7)	38(10.1)		
B3											
	120(32)	120(32)	120(32)	120(32)	100(26.6)	100(26.6)	95(25.3)	82(21.9)	75(20)	65(17.3)	
				89(23.7)		84(22.4)	77(20.5)	70(18.7)	62(16.5)		
B20											
	28(7.5)	19(5.1)	15(4.0)	10(2.7)	120(32)	120(32)	95(25.3)	74(19.7)	61(16.3)	43(11.5)	
				95(25.3)		84(22.4)	63(16.8)	50(13.3)	34(9.1)		
D2											
	40(10.7)	40(10.7)	30(7.8)	28(7.5)	60(16)	40(10.7)	40(10.7)	40(10.7)	30(18)	28(7.5)	
D3											
	60(16)	60(16)	42(11.2)	36(9.6)	70(18.7)	60(16)	60(16)	60(16)	42(11.2)	36(9.6)	

低衝擊型式DWH-G03系列

型號說明
DWH - G 03 - C2 - R220 - 10 - M
1 2 3 4 5 6 7

- 1 濕式電磁操作方向閥
- 2 板式連結
- 3 公稱口徑：10通徑
- 4 閥柱型式：C2、C3、C4、C6、B2、B3符號詳見第19頁閥柱型式表
- 5 電磁線圈電壓分類：
 - R220: AC220V/50, 60HZ交流轉直流
 - R110: AC110V/50, 60HZ交流轉直流
 - D24: DC24V
 - D12: DC12V
- 6 設計型號：
 - 10: 接線盒式
 - 20: DIN 43650插座接線式
- 7 附加編號
 - 標準：無
 - M: 低衝擊型式

型式及重量表

型號	重量 Kgf(LB)	型號	重量 Kgf(LB)
DWH-G03-C**-A***-10-**	4.3(9.46)	DWH-G03-C-A***-20-**	4.3(9.46)
DWH-G03-B**-A***-10-**	3.6(7.92)	DWH-G03-B-A***-20-**	3.5(7.7)
DWH-G03-C**-D/R***-10-**	5.5(12.1)	DWH-G03-C-D/R***-20-**	5.4(11.88)
DWH-G03-B**-D/R***-10-**	4.2(9.24)	DWH-G03-B-D/R***-20-**	4.1(9.02)
DWH-G03-D**-A***-10-**	4.3(9.46)	DWH-G03-D-A***-20-**	4.3(9.46)
DWH-G03-D**-D/R***-10-**	5.5(12.1)	DWH-G03-D-D/R***-20-**	5.5(12.1)

使用性能參數

最高工作壓力	210kgf/cm ² (3000 PSI)	
最大通過流量	80 LPM (21.3 GPM)	
最大允許背壓	160 kgf/cm ² (2350PSI)	
最高切換頻率	240 CPM	
流體過濾精度	25 Micron	
防護等級	耐候性符合IP65等級要求	
流體溫度範圍	0°C~ 55°C	
工作環境溫度	-25°C ~ 90°C	
流體黏度範圍	10-400 CST	
固定螺絲扭矩	50 ~ 70 Kgf-cm	
固定螺絲規格	公制	M6×35長×4支
	英制	#1/4-20UNC×1-3/8"長×4支

電磁線圈性能參數

電磁線圈	種類	電壓 (V)			電流及功率		
		適用電壓 (V)	頻率 (Hz)	允許範圍 (±10%)	啓動電流 (A)	保持電流 (A)	功率 (W)
R.F	R110	AC110V	50/60	99-126	0.47	0.47	46
	R220	AC220V	50/60	198-253	0.24	0.24	46
D.C.	D12	DC12V		10.8-13.2	2.58	2.58	32
	D24	DC24V		21.6-26.4	1.33	1.33	32

■ 技術參考資料:

耐電壓測試1500v/sec。

絕緣電阻100mΩ以上。

特殊電壓請洽本公司業務部。

壓力降特性測試

■ 測試系統:

1. 受測電磁閥
2. 油泵
3. 壓力感測器
4. 流量感測器
5. 壓力閥
6. 流量調整閥

■ 測試條件:

- 壓力: 70kgf/cm² (1000PSI)
 流量: 120 LPM (32GPM)
 黏度: 35 CST

測試迴路

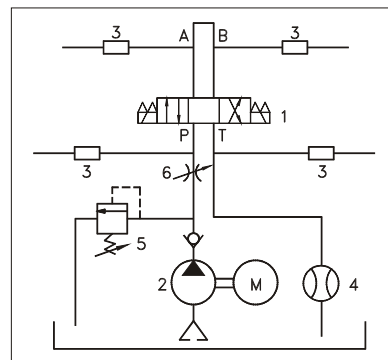

■ 壓力降曲線表:

閥柱型式	壓力降曲線編號				
	P→A	B→T	P→B	A→T	P→T
C2	1	1	1	1	—
C3	5	5	5	5	2
C4	1	1	1	1	—
C6	4	4	4	4	3
B2	2	2	2	2	—
B3	2	2	2	2	—

■ 壓力降曲線圖

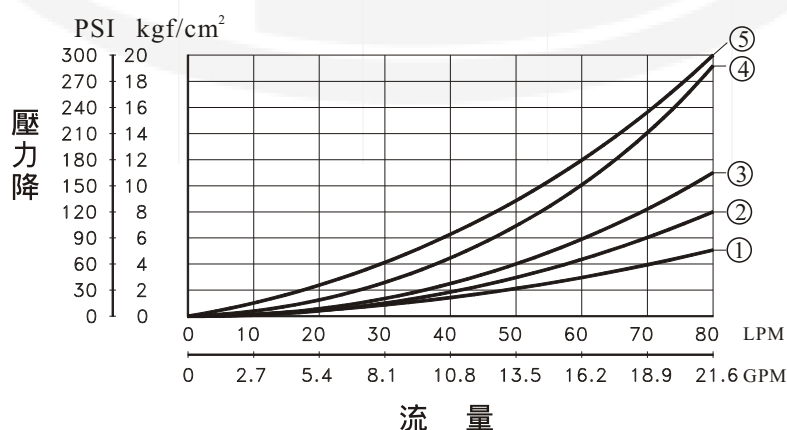

■ 黏度比對系數

黏度	CST	15	20	30	40	50	60	70	80	90	100
	SSU	77	98	141	186	232	278	324	371	417	464
系數(G)		0.81	0.87	0.96	1.03	1.09	1.14	1.19	1.23	1.27	1.30

■ 壓力損失 ($\Delta P'$) 可從下列公式計算得之 $\Delta P' = \Delta p(G'/0.85)$

電磁方向閥性能參數表

各種閥柱在各階段壓力 kgf/cm ² (PSI)所能通過的最大流量LPM(GPM)												
閥柱型號 常態位置	P→A, B→T P→B, A→T				P→A				P→B			
	50 (735)	100 (1470)	150 (2200)	210 (3000)	50 (735)	100 (1470)	150 (2200)	210 (3000)	50 (735)	100 (1470)	150 (2200)	210 (3000)
C2	80 (21.3)	80 (21.3)	80 (21.3)	80 (21.3)	80 (21.3)	80 (21.3)	80 (21.3)	67 (17.9)	80 (21.3)	80 (21.3)	80 (21.3)	67 (17.9)
C3	80 (21.3)	80 (21.3)	80 (21.3)	67 (17.9)	80 (21.3)	50 (13.3)	32 (8.5)	28 (7.5)	80 (21.3)	50 (13.3)	32 (8.5)	28 (7.5)
C4	80 (21.3)	80 (21.3)	80 (21.3)	80 (21.3)	80 (21.3)	80 (21.3)	80 (21.3)	80 (21.3)	80 (21.3)	80 (21.3)	80 (21.3)	80 (21.3)
C6	80 (21.3)	30 (8)	28 (7.5)	20 (5.3)	80 (21.3)	35 (9.3)	30 (8)	20 (5.3)	80 (21.3)	35 (9.3)	30 (8)	20 (5.3)
B2	80 (21.3)	80 (21.3)	80 (21.3)	28 (7.5)	70 (18.7)	70 (18.7)	70 (18.7)	70 (18.7)	70 (18.7)	70 (18.7)	70 (18.7)	70 (18.7)
B3	80 (21.3)	80 (21.3)	80 (21.3)	80 (21.3)	80 (21.3)	80 (21.3)	80 (21.3)	80 (21.3)	80 (21.3)	80 (21.3)	80 (21.3)	80 (21.3)

反應時間測試
■ 測試系統:

1. 受測電磁閥
2. 油泵
3. 壓力感測器
4. 流量感測器
5. 壓力閥
6. 流量調整閥

■ 測試條件:

壓力: 160kgf/cm² (2350PSI)
 流量: 140 LPM (37.3GPM)
 黏度: 35 CST

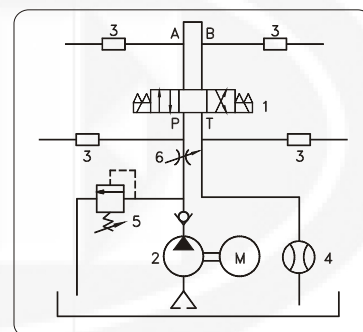
測試迴路

■ 測試結果:

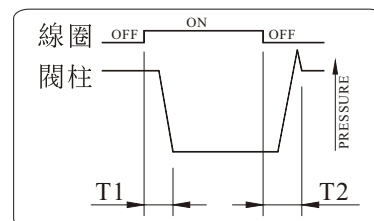
型號	反應時間(SEC)	
	T1	T2
DWH-G03-RF-M	0.1-0.15	0.1-0.15
DWH-G03-DC-M	0.1-0.15	0.1-0.15



安裝外型尺寸圖

固定面標準: ISO 4401-AC-05-4-A
單位: mm(inch)

■ DWH-G03-C**-A***-10 DWH-G03-B**-A***-10

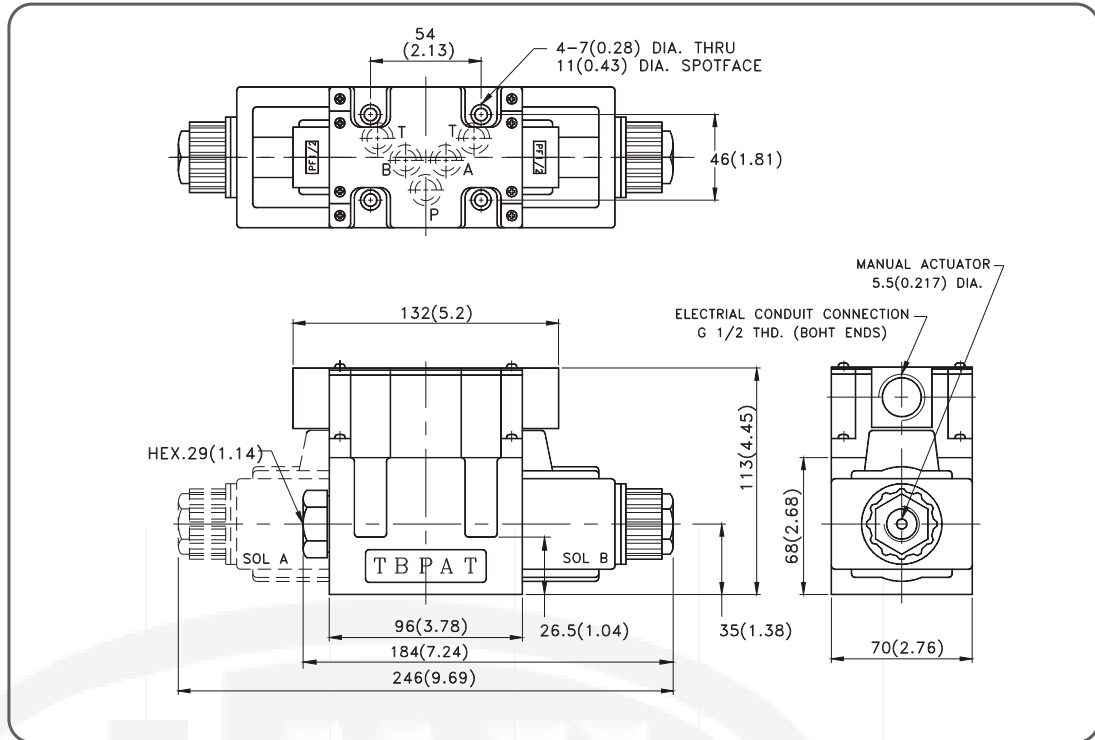

■ DWH-G03-C**-D/R**-10 DWH-G03-C**-D/R**-10

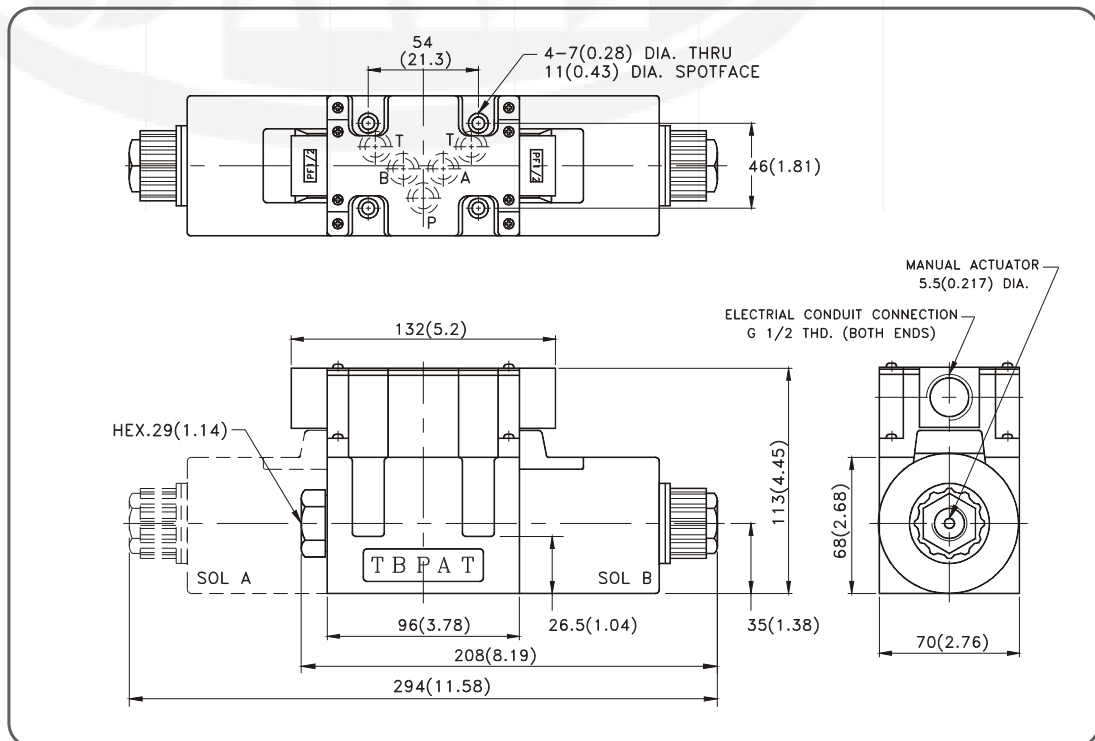

安裝外型尺寸圖

固定面標準: ISO 4401-AC-05-4-A
單位: mm(inch)

■ DWH-G03-C**-A***-20 DWH-G03-B**-A***-20

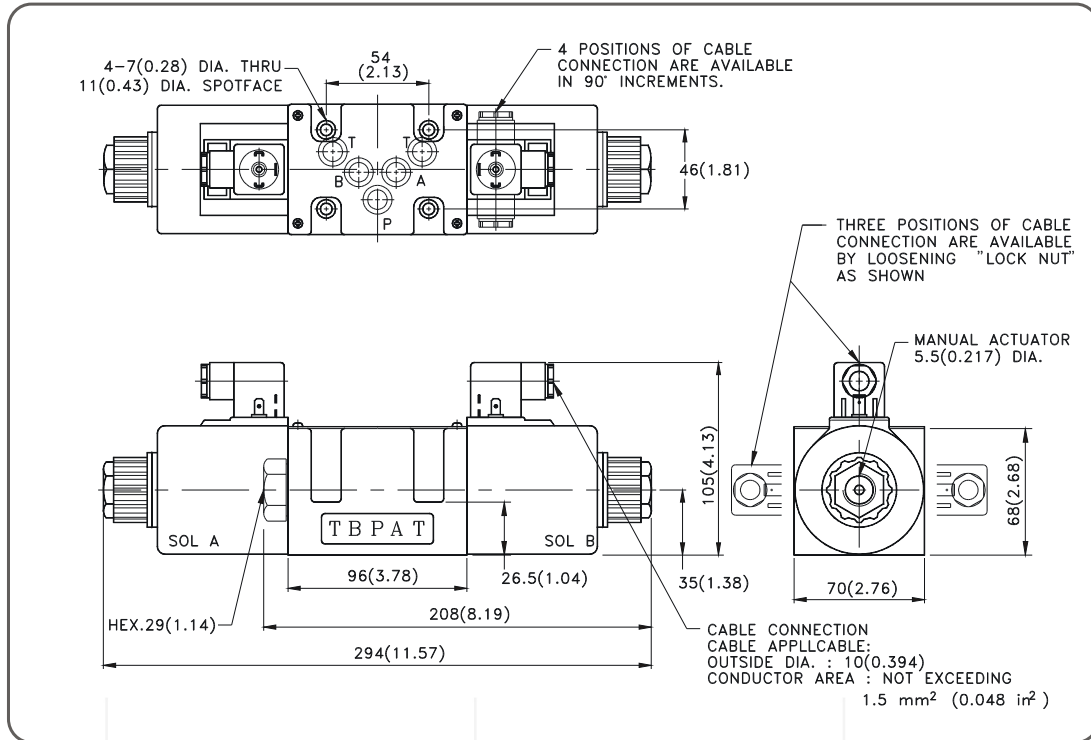

■ DWH-G03-C**-D/R**-20 DWH-G03-C**-D/R**-20

